

# UHS Orbis 20" 1500 rpm Base Assembly Service Parts List

Used on Truvox Machine (OB501500) 230v 50hz (Series G) Serial Numbers 04569 Onwards

Model Ref.:- 05-3782-0000

Service Parts List Issue 11 Dated 01-August-2017

Ref. Drawing 09-1054-0000 Issue B Dated 18th June 2009

Drawing Ref.	Current Part Number	Description	Qty
1	02-3121-0000	WHEEL 8IN	2
2	02-4011-0000	INTERNAL CIRCLIP	1
3	02-4541-0000	SPRING (PART OF 10-0019-0000)	3
4	10-0019-0000	ORBIS UHS FLOATING ADAPTOR 20" 1500 RPM	1
7	02-3847-0000	BEARING 6003-2RS	1
8	02-3848-0000	BEARING 626-2RS	2
9	02-3856-0000	UHS ORBIS DRIVE BELT	1
12	02-4551-0000	SNAP HOOK BLACK PLASTIC *NOT SHOWN*	1
13	02-3853-0000	PAD CENTRE LOCK (PART OF 05-4086-0000)	1
16	03-5307-0000	IDENT LABEL COVER - SELF ADH. VINYL SIZE 75x50 *NOT SHOWN*	1
17	03-5866-0000	DATA PLATE *NOT SHOWN*	1
18	03-5869-0056	YELLOW LABEL BLANK 50MM X 100MM *NOT SHOWN*	1
19	02-3124-0000	WHEEL CAP	1
20	03-6684-0067	BRUSH GUARD 20" (JET BLACK)	1
21	03-6728-0000	VAC SKIRT PVC EXTRUSION	1
22	03-6126-0000	INSPECTION AND TEST RECORD TAG *NOT SHOWN*	1
25	03-6681-0035	UHS ORBIS BASE MOULD (WATER BLUE)	1
26	03-6682-0067	UHS ORBIS MOTOR COVER (JET BLACK)	1
27	03-6683-0035	ORBIS UHS FAN COVER (WATER BLUE)	1
28	03-6685-0057	UHS ORBIS DUST COLLECTION BOX (ORANGE)	1
30	03-6703-0000	UHS ORBIS MATERIAL VAC BAG	1
31	03-6712-0000	UHS ORBIS 1500 DECAL (FAN COVER) *NOT SHOWN*	1
32	03-6714-0000	UHS ORBIS STUB AXLE	2
34	03-6719-0000	UHS ORBIS DRIVE SPINDLE	1
35	03-6720-0000	UHS ORBIS URETHANE WHEEL	1
36	03-6721-0000	UHS ORBIS CASTER CAGE	1
37	03-6722-0000	UHS ORBIS BEARING SLEEVE	1
38	03-6723-0000	UHS ORBIS MOTOR MOUNT PLATE	1
39	03-6725-0000	UHS ORBIS MOTOR PULLEY	1
40	03-7639-0000	ORBIS UHS PACKAGING CARTON *NOT SHOWN*	1
41	03-7821-0000	ORBIS UHS Multilingual Instructions *NOT SHOWN*	1
44	<b>SEE BELOW NOTE</b>		
45			
46			
47	04-0279-0000	CABLE TIE	2
48	04-3235-0000	SNAP IN C14 APPLIANCE INLET	1
49	<b>SEE BELOW NOTE</b>		
50	04-3911-0000	UHS ORBIS BASE WIRE KIT *NOT SHOWN*	1
51	N/A		
52	05-3767-0000	20" UHS VACUUM SKIRT ASSY	1
54	05-4086-0500	UHS PAD DRIVE ASSEMBLY 20"	1
55	10-0019-0000	ORBIS UHS FLOATING ADAPTOR ASSEMBLY 20" 1500 RPM	1
		<b>FASTENERS</b>	
60	00-0400-0723	M4 NYLOC NUT ST/ST	2
61	00-0520-0111	M5 x 20 HEX HEAD BOLT	1
62	00-0416-0111	M4 x 16 SCREW	1
63	00-0600-0511	M6 SPRING WASHER	2
64	00-0600-0553	M6 PLAIN WASHER ST/ST	2
65	00-0600-0721	M6 NYLOC NUT	6
66	00-0600-0751	M6 HALF NYLOC NUT	1
67	00-0616-0031	M6 x 16 COUNTER SINK POZI HD SCREW	6
68	00-0616-0111	M6 x 16 SCREW	2

69	00-0635-0111	M6 x 35 SCREW	6
70	00-0800-0513	M8 SPRING WASHER	5
71	00-0800-0553	M8 PLAIN WASHER ST/ST	5
72	00-0800-0711	M8 LOCKNUT	1
73	00-0800-0721	M8 FULL NYLOC NUT	1
74	00-0816-0111	M8 x 16 BOLT	4
75	00-0830-0091	M8 x 30 CAP HEAD SCREW	1
76	00-0890-0121	M8 x 90 BOLT	1
77	00-2000-0501	M20 PLAIN WASHER	1
78	00-2000-0521	M20 SHAKEPROOF WASHER	1
79	00-2000-0701	M20 NUT	1
80	02-0254-0000	STARLOCK WASHER	2
81	02-3127-0111	WASHER 1/4" x 3/4"	2
82	02-3250-0000	M8 SHAKEPROOF WASHER	1
84	02-3467-0000	KB60 x 18 SELF TAPPER	3
85	02-3515-0000	KB60 x 40 SELF TAPPER	6
86	02-3523-0000	SHOULDER BOLT 40mm	3
<b>Motor 1 - TACONY</b>			
44	04-3501-0500	RUN CAPACITOR 30uF	1
45	04-3956-0000	START CAPACITOR 150 Uf	1
46	04-3974-0000	MOTOR RELAY	1
49	04-3411-0500	MOTOR 230V 50Hz 1100W 4 POLE	1
<b>Motor 2 - LEMAC</b>			
44	04-3957-0000	RUN CAPACITOR 25uF	1
45	04-3956-0000	START CAPACITOR 150 Uf	1
46	04-3925-0000	MOTOR RELAY	1
49	04-3939-0000	OBSOLETE USE 04-3411-0500	1
<b>Motor 3 - LEROY</b>			
44	04-3228-0000	RUN CAPACITOR 32uF	1
45	04-3230-0000	START CAPACITOR 80 Uf	1
46	04-3150-0000	MOTOR RELAY	1
49	04-3909-0000	OBSOLETE USE 04-3411-0500	1
<b>Motor 4 -Tyco</b>			
44	04-3719-0000	RUN CAPACITOR 30uF	1
45	04-3720-0000	START CAPACITOR 120 Uf	1
46	04-3721-0000	MOTOR RELAY	1
49	04-3411-0000	OBSOLETE USE 04-3411-0500	1

Truvox reserves the right to change specifications without prior notice

Service & Spares: 023 80706601  
 Customer Services: 023 80706600  
 General Enquiries: 023 80702200

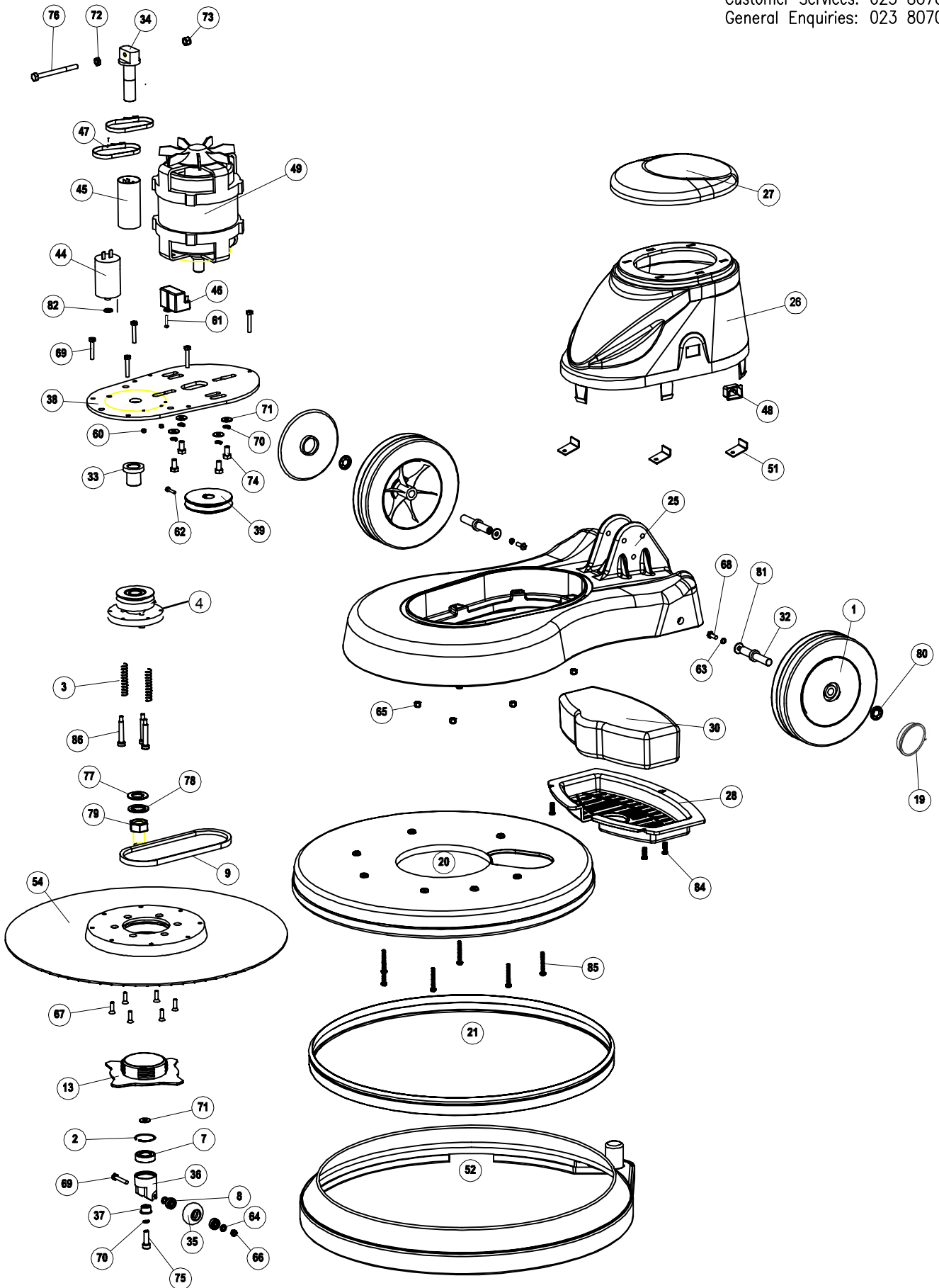

27.07.17		D	DRIVE PULLEY KIT	ND		SCALE	NTS	TITLE	ORBIS UHS 20" 1500 GENERIC BASE DRAWING		
07.03.2016		C	WHEEL CAP	ND							
18.06.09		B	MOTOR CHANGE	MC	MC	CHECKED		PRODUCT	DRAWING/PART No		
13.12.05		A	NEW DRAWING	SJ	SJ	DRN		UHS 1500	09-1054-0000	A4	SHEET 1 OF 1 SHEETS
DATE	CRO No	ISS	REVISION RECORD	DR	CHK	SJ					

PART No.  
09-1115-0000

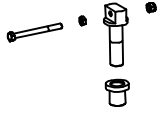

KIT NO.	PART NO.	DESCRIPTION
4	10-0006-0000	MOTOR PULLEY KIT
5	10-0019-0000	DRIVE PULLEY KIT
6	02-3856-0000	DRIVE BELT
7	05-4086-0500	FLEXI DRIVE DISC ASSEMBLY 20" KIT
8	02-3853-0000	PAD CENTRE LOCK RING
9	10-0007-0000	CASTOR ASSEMBLY KIT
10	05-3767-0000	VACUUM SKIRT 20"
11	10-0015-0000	BRUSH GUARD 20" KIT
12	10-0009-0000	DUST COLLECTION BOX KIT
13	03-6703-0000	DUST COLLECTION BAG (REUSABLE)
14	10-0010-0000	WHEEL ASSEMBLY KIT
15	10-0011-0000	MOTOR COVER ASSEMBLY KIT

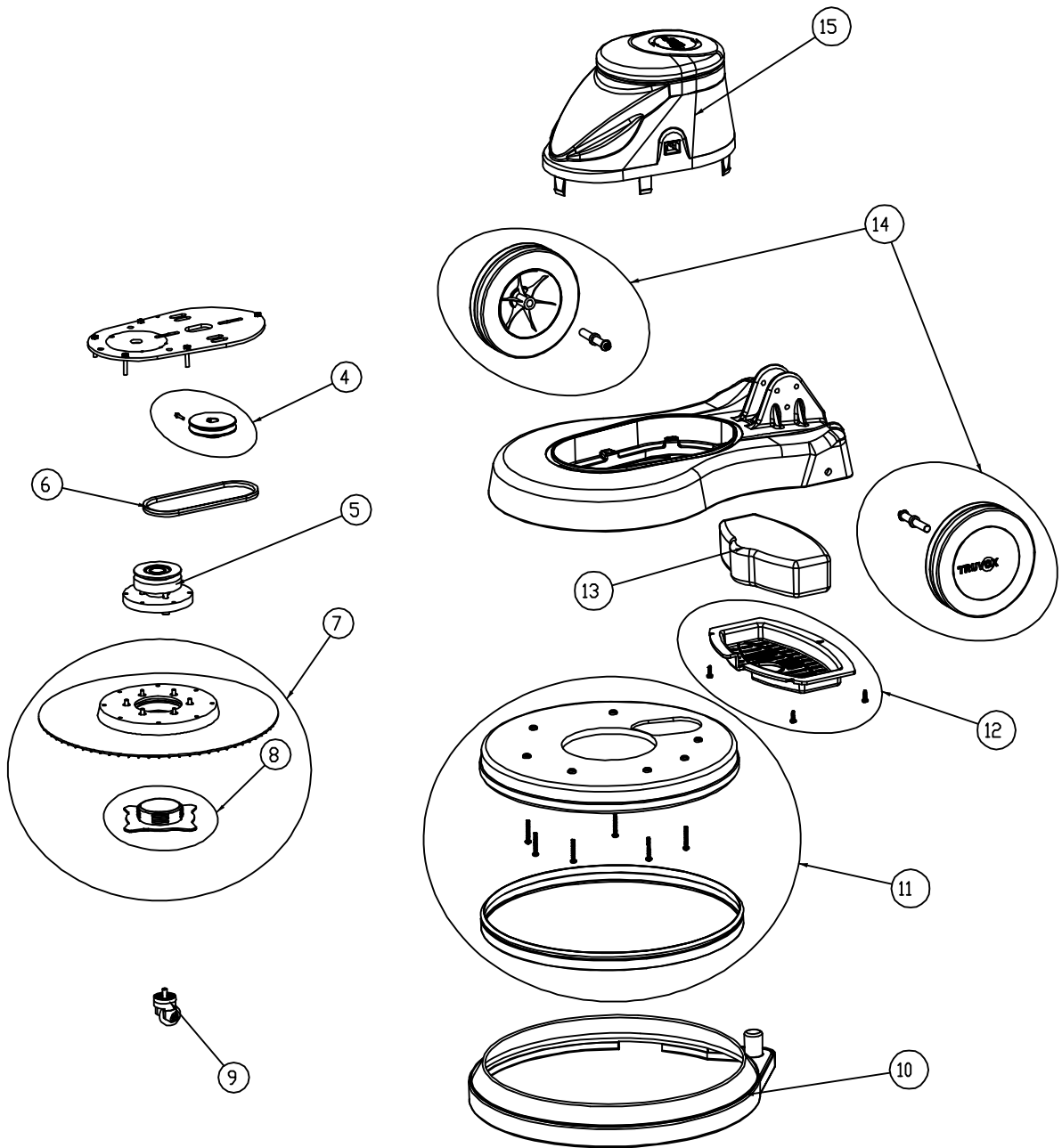

ISSUE	C/N	CHANGES	INT	DATE	MATERIAL	GEN TOL	SCALE	NTS	TITLE	PART No.
C		REMOVE MOTOR, CAPACITOR, RELAY	ND	27.07.17	NA	NA			<b>TRUVOX<sup>TM</sup> INTERNATIONAL LIMITED</b> UHS ORBIS 1500 20" KIT LIST	09-1115-0000
B		UPDATE P/N	ND	07.08.14	FINISH#					
A	NA	NEW DRAWING	MC	22.06.09	NA	DRW#	CKD#			

# Ultra High Speed Orbis Handle Assembly Service Parts List

Model Ref.:- 05-4628-0000 (UK Plug) & 05-4629-0000 (Euro Plug)

Service Parts List Issue 8 Dated 01-August-2017

Ref. Drawing 09-1002-0000 Issue B Dated 03-September-2013

Drawing Ref.	Current Part Number	Description	Qty
1	02-3151-0000	P Clip	1
2	02-3152-0000	Cable Strain Relief Bracket	1
3	02-3186-0000	Ball bearing	2
4	02-3510-0000	Handle Interlock Spring	2
5	02-3511-0000	Gear dog Spring	1
6			
7	02-3520-0000	Diaphragm Grommet	1
8	02-3521-0000	13mm Spanner for ORBIS <b>(Not Shown)</b>	2
9	03-5403-0000	Cable winder	1
10	03-5410-0000	Cable Winder Spring	1
11	03-6085-0000	Tube - handle aluminium ext.	1
12	03-6086-0067	Handle main - front Jet Black RAL 9005	1
13	03-6087-0067	Handle main - rear Jet Black RAL 9005	1
14	03-6088-0067	Solution Lever Jet Black RAL 9005	1
15	03-6089-0067	Gear lever Jet Black RAL 9005	1
16	03-6090-0067	Trigger left and right Jet Black RAL 9005	2
17	03-6091-0000	Handle Rubber boot	2
18	03-6092-0067	Interlock Jet Black RAL 9005	2
19	03-6093-0067	Cord inlet box Jet Black RAL 9005	1
20	03-6094-0067	Cord retainer Jet Black RAL 9005	1
21	03-7831-0000	Knuckle Moulding	1
22	03-6096-0000	Gear	1
23	03-6097-0000	Dog	1
24	03-6098-0000	Adjusting Gear Rod	1
25	03-6120-0000	Instruction Manual <b>(Not Shown)</b>	1
26	04-0237-0000	Cable clamp	1
27	04-3254-0000	Neon Indicator Green	1
28	03-6693-0067	Handle Socket Blanking Plate	1
29a	04-3407-0000	UHS 20M Supply Cord Set	1
29b	04-3408-0000	UHS Europlug 20M Supply Cord Set	1
30	04-3237-0000	Switch	1
31	04-3937-0000	Handle Wiring Kit Without Power Take Off <b>(Not Shown)</b>	1
32	04-3679-0000	UHS Extended Drop lead	1
33	04-3242-0000	16Amp Inlet Socket	1
34	10-0123-0000	Orbis Handle Power Take Off Kit <b>(Not Shown)</b>	1
35	04-3239-0000	Handle Wiring Kit With Power Take Off <b>(Not Shown)</b>	1
		<b>Fasteners</b>	
40	02-3516-0000	Self Tapper (Main Handle / Cord Inlet Box)	11
41	02-3517-0000	Self Tapper (Handle Ends)	2
42	02-3518-0000	Self Tapper (Cable Clamps)	2
43	00-0650-0011	Handle Tube Fix M6 x 55 Pozi Pan Head Screw	2
44	00-0600-0521	Handle Tube Fix M6 Shakeproof	2
45	00-0600-0701	Handle Tube Fix M6 Full Nut	2
46	00-0875-0121	Handle Attachment Bolt M8 x 75 Hex Head Bolt	3
47	02-0223-0000	Handle Attachment Washer Zinc Washer 5/16" x 1 1/4"	6
48	00-0800-0751	Handle Attachment Nut M8 Type "T" 1/2 Nyloc Nut	3
49	00-0816-0111	Knuckle Bolt M8 x 16 Hex Head	2
50	00-0800-0501	Knuckle Washer M8 "A" Form Washer	2
51	00-0800-0731	Knuckle Nut M8 Binx Nut	2
53	02-3523-0000	New Cable Winder Bolt Socket Shoulder Bolt M6 x 8 x 40	1
54	00-0520-0111	Earth Mount on Handle M5 x 20 Hex Head	1
55	00-0500-0531	Earth Mount on Handle Serrated Washer M5 External	1
56	00-0500-0511	Earth Mount on Handle Spring Washer M5 Single Coil	1
57	00-0500-0701	Earth Mount on Handle Fixing Nuts M5 Full Nut	2
58	00-0520-0111	Cable Restraint Bolt M5 x 20 Hex Head Screw	1
59	00-0500-0701	Cable Restraint Nut M5 Full Nut	1
60	00-0500-0501	Gear Rod Washer M5 Washer	1
61	00-0500-0701	Gear Rod Nuts M5 Full Nut	2

Service & Spares: 023 80706601  
 Customer Services: 023 80706600  
 General Enquiries: 023 80702200

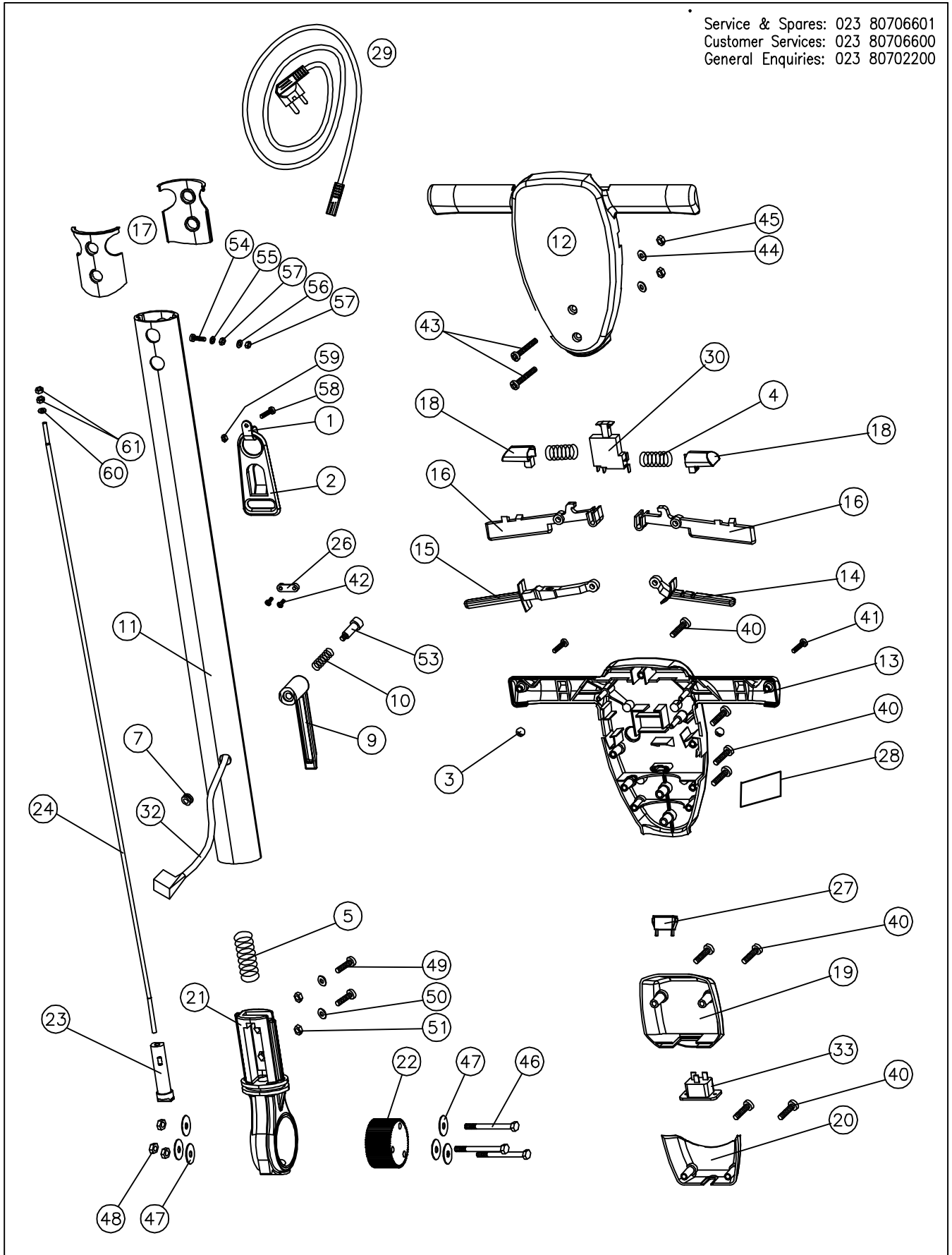

23.02.16		C	REMOVE ITEM 52	ND	SCALE	NTS	TITLE	G.A	
03.09.13		B	POWER TAKE OFF	ND	CHECKED				
10.05.01	-	A	NEW DRAWING	CL	DRN	10.5.01	PRODUCT	DRAWING/PART No	
DATE	CRO No	ISS	REVISION RECORD	DR	CHK		ORBIS HANDLE ASSY.	09-1002-0000	A4
									SHEET 1 OF 1 SHEETS

# WIRING SCHEMATIC ORBIS UHS MACHINES TACONY MOTOR

SNAP IN  
APPLIANCE INLET  
04-3235-0000

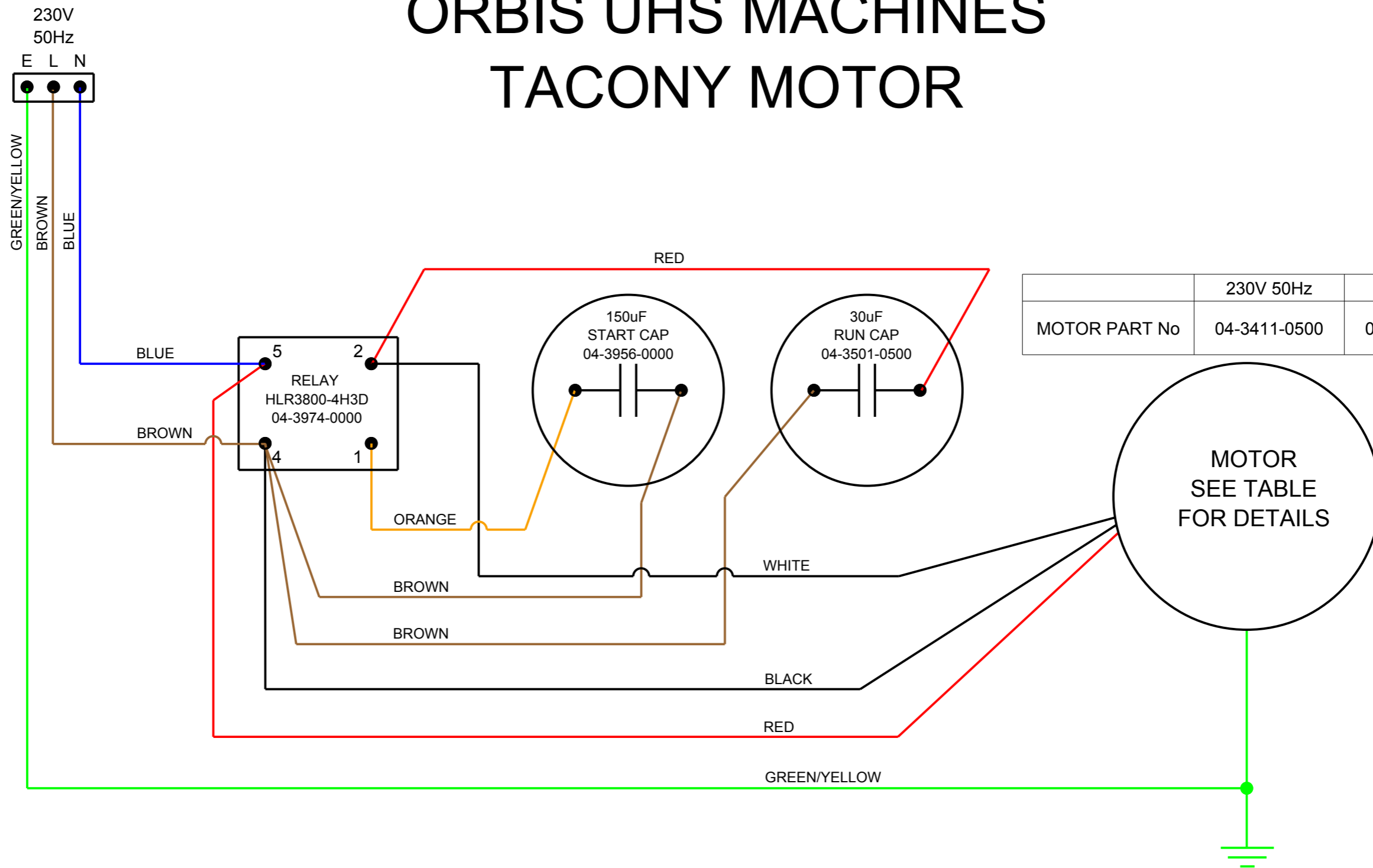

	230V 50Hz	230V 60Hz
MOTOR PART No	04-3411-0500	04-3960-0500

MOTOR  
SEE TABLE  
FOR DETAILS

3	1206	TABLE ADDED TO INCLUDE 60Hz MOTOR	NMN	10 AUG 17
2	1205	WIRE COLOURS CHANGED	NMN	03 AUG 17
1	N/A	PRODUCTION RELEASE	NMN	26 JUL 17
A	N/A	NEW DRAWING	NMN	10 JUN 12
ISSUE	ECN	CHANGES	INT	DATE

MATERIAL:	GEN TOL X ± 0.5 X.X ± 0.2 X.XX ± 0.1 ANG ± 0.5°
FINISH:	SCALE: X : X DRN CKD NMN

TM <b>TRUVOX INTERNATIONAL LIMITED</b>	
TITLE: UHS BASE WIRING - TACONY MOTOR - 230V 50Hz & 60Hz	PART NO. 09-1131-0000

# WIRING SCHEMATIC ORBIS UHS MACHINES LEMAC MOTOR

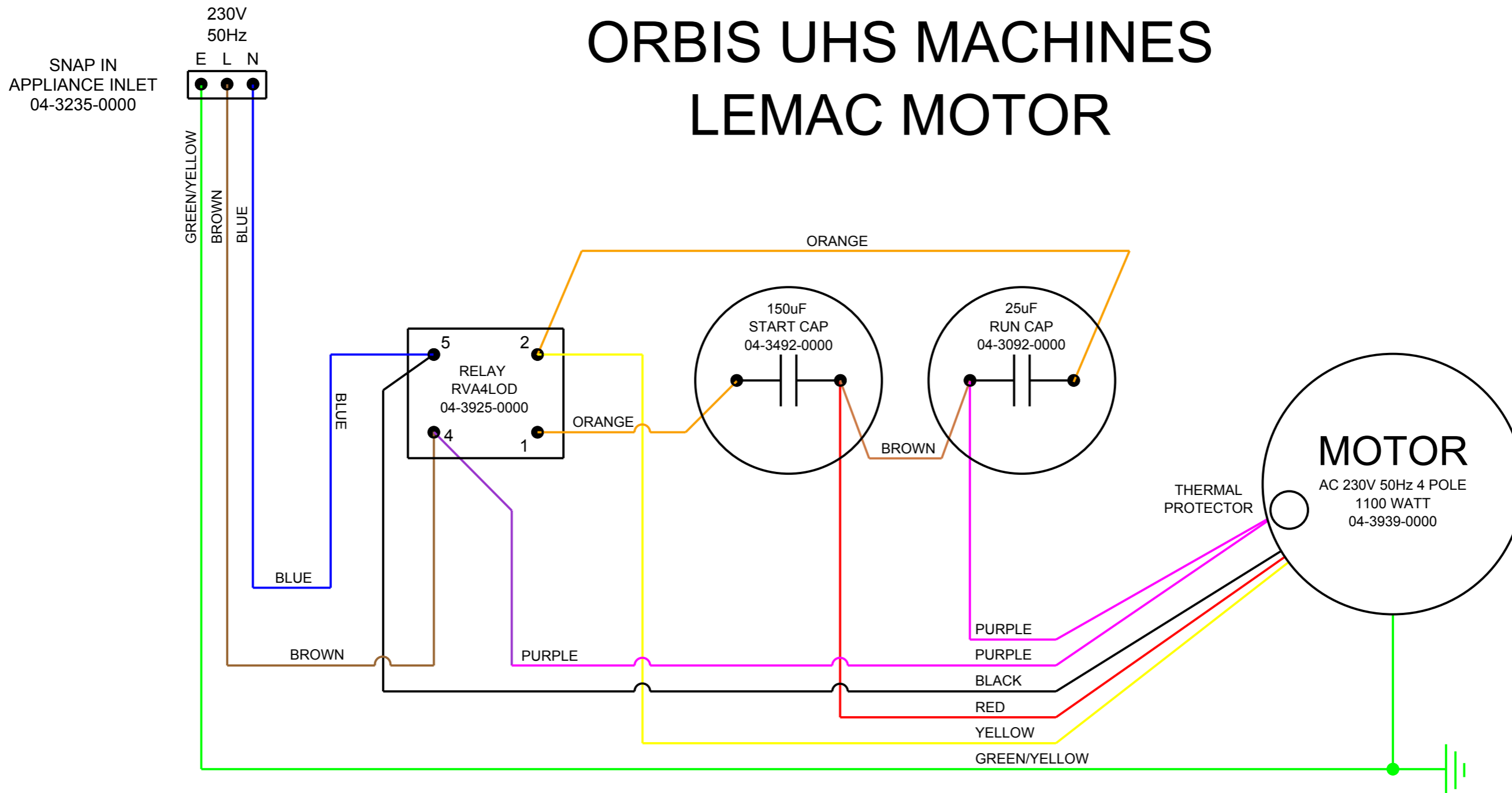

2	1081	WIRING MODIFIED	NMN	28 OCT 13
1	N/A	MOTOR WAS LEROY - NOW LEMAC	NMN	02 FEB 12
A	N/A	NEW DRAWING	MDC	02 JUN 09
ISSUE	ECN	CHANGES	INT	DATE

MATERIAL:	GEN TOL X ± 0.5 X.X ± 0.2 X.XX ± 0.1 ANG ± 0.5°
FINISH:	SCALE: X : X
	DRN CKD NMN

TRUVOX INTERNATIONAL LIMITED <small>TM</small>	
TITLE: UHS BASE WIRING DIAGRAM (230V 50Hz) LEMAC	PART NO. 09-1113-0000



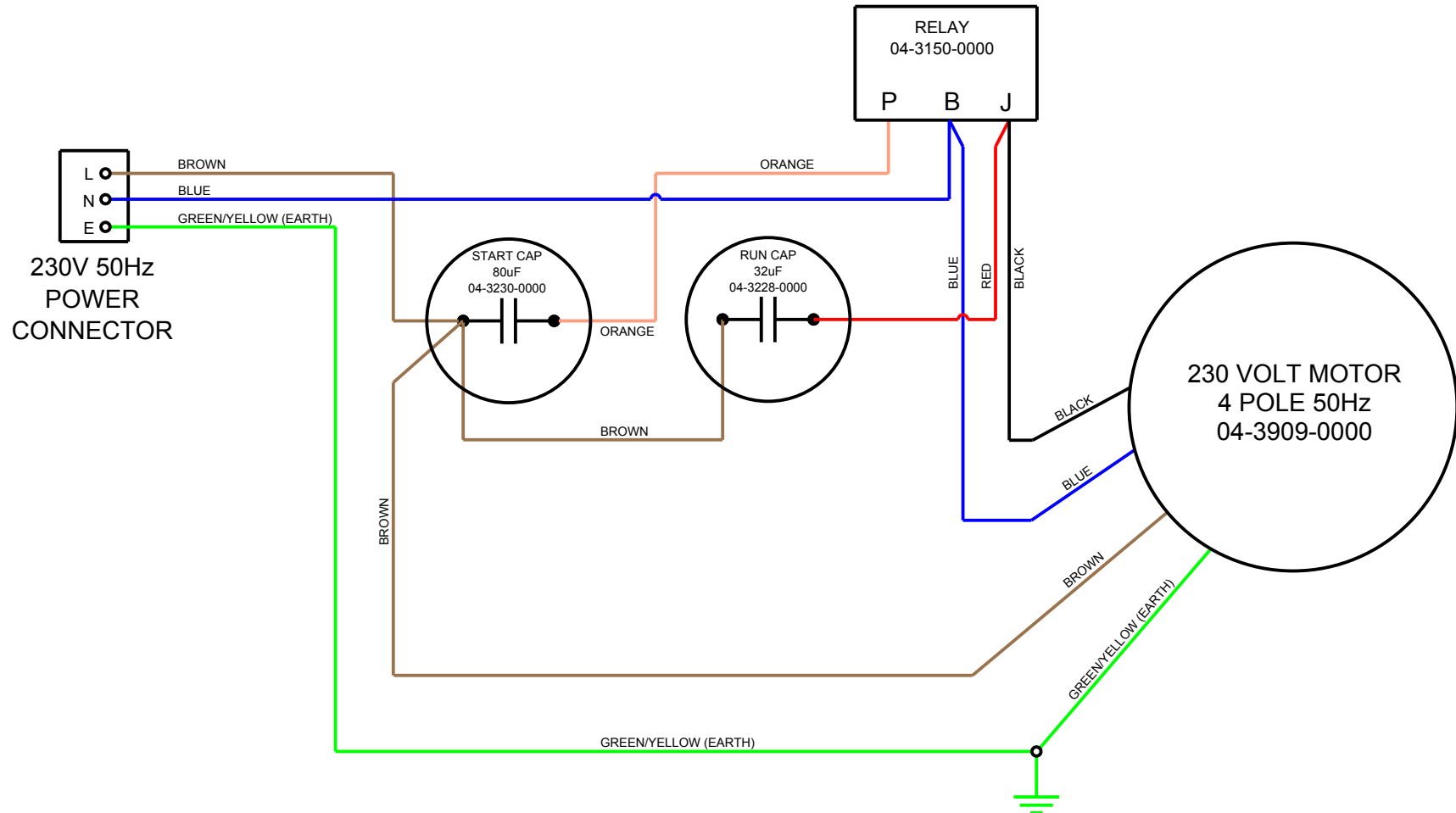

			MATERIAL:		GEN TOL X ±0.5 X.X ±0.2 X.XX ±0.1 ANG ±0.5°		TM <b>TRUVOX INTERNATIONAL LIMITED</b>		
			FINISH:		SCALE: X : X		TITLE:		
A	N/A	NEW DRAWING	MDC	02 JUN 09	DRN	CKD	ORBIS UHS BASE WIRING DIAGRAM (230V 50Hz) LEROY		
ISSUE	ECN	CHANGES	INT	DATE	NMN		PART NO. 09-1113-0000		

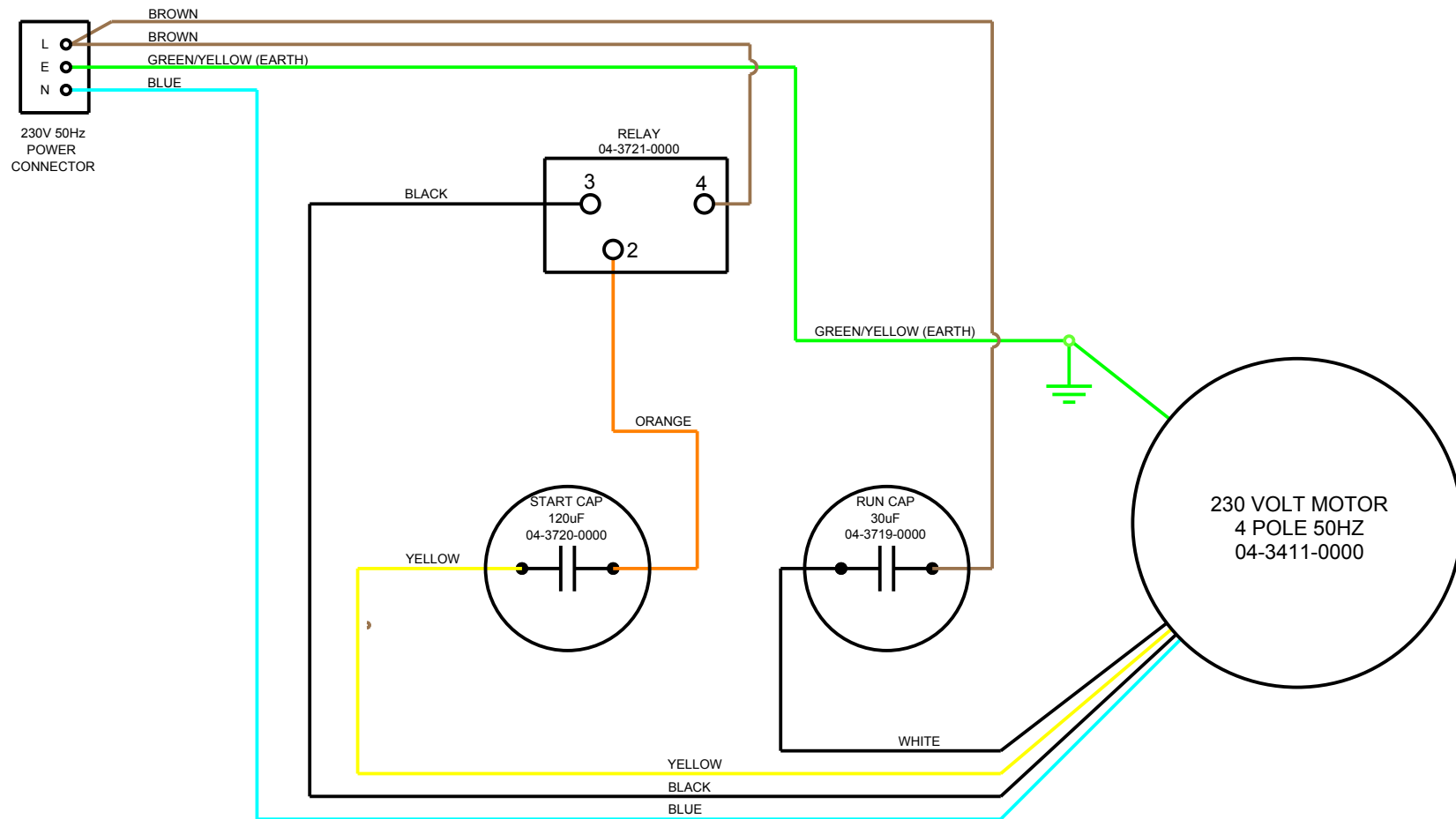

			MATERIAL:		GEN TOL X ±0.5 X.X ±0.2 X.XX ±0.1 ANG ±0.5°		TM <b>TRUVOX INTERNATIONAL LIMITED</b>	
			FINISH:		SCALE: X : X			
A	N/A	NEW DRAWING	SJ	17 AUG 04	DRN	CKD	ORBIS UHS BASE WIRING DIAGRAM - TYCO MOTOR	
ISSUE	ECN	CHANGES	INT	DATE	NMN		PART NO. 09-1032-0000	